

Osa! Auto!

Feeders & Grippers



NEO TRAY LINEAR

Tray type

Mini Tray, Jedec Tray

Tape width

55 a 100 mm

Feeder dimensions

100 mm

Quick clamping system

Feed rate

3,600 trays/hour

Weight

8.5 kg

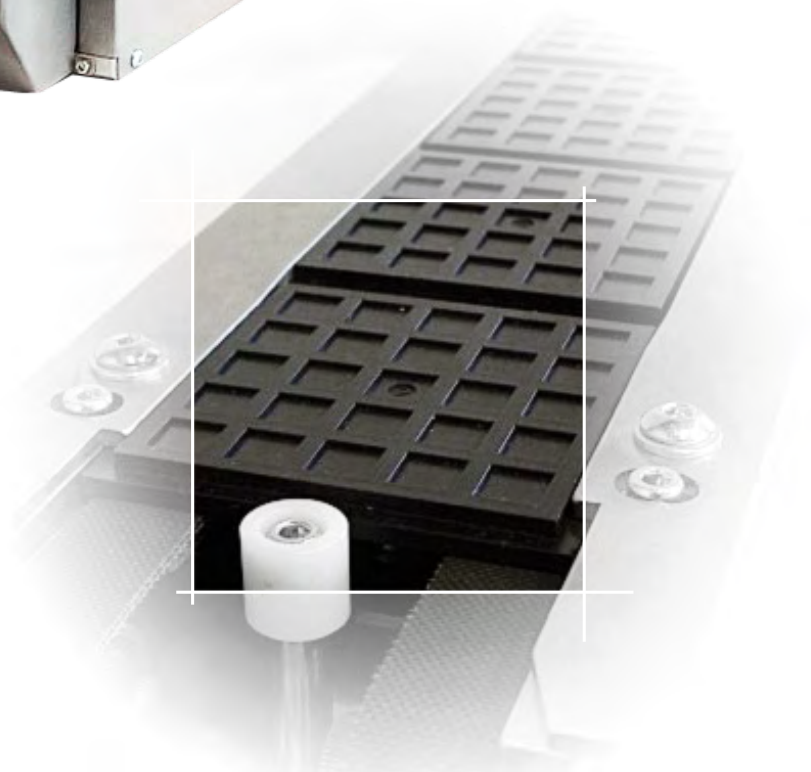
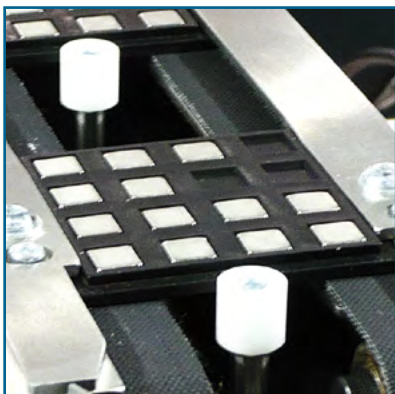

NEORADIAL

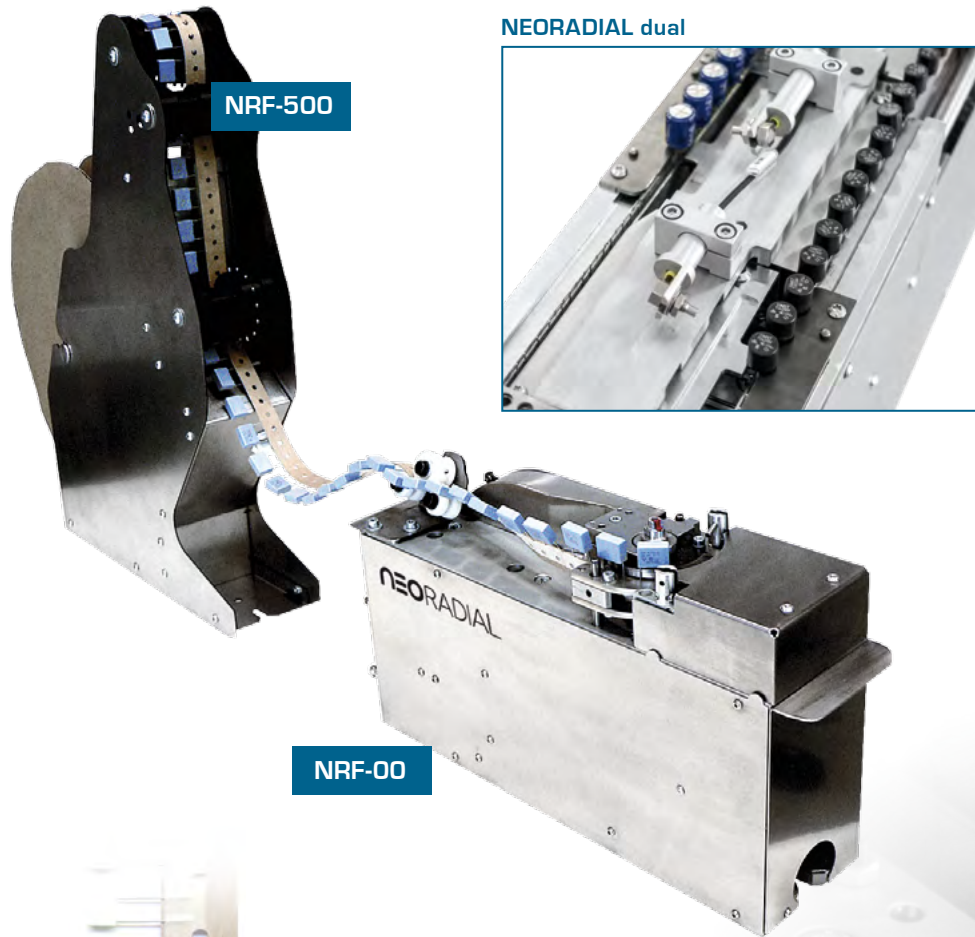

NEORADIAL dual

NRF-500

NRF-00

Taping type
pitch 12.7 mm
Other on demand

Rheophore diameter
0.4 to 1.1 mm

Feeder dimensions
100 mm
Quick clamping system

Component feed rate
3,600 comp./hour

Weight
8.5 kg

Cutting knife

00-NRF-2900

Component types
Capacitors, varistors,
transistors, LED

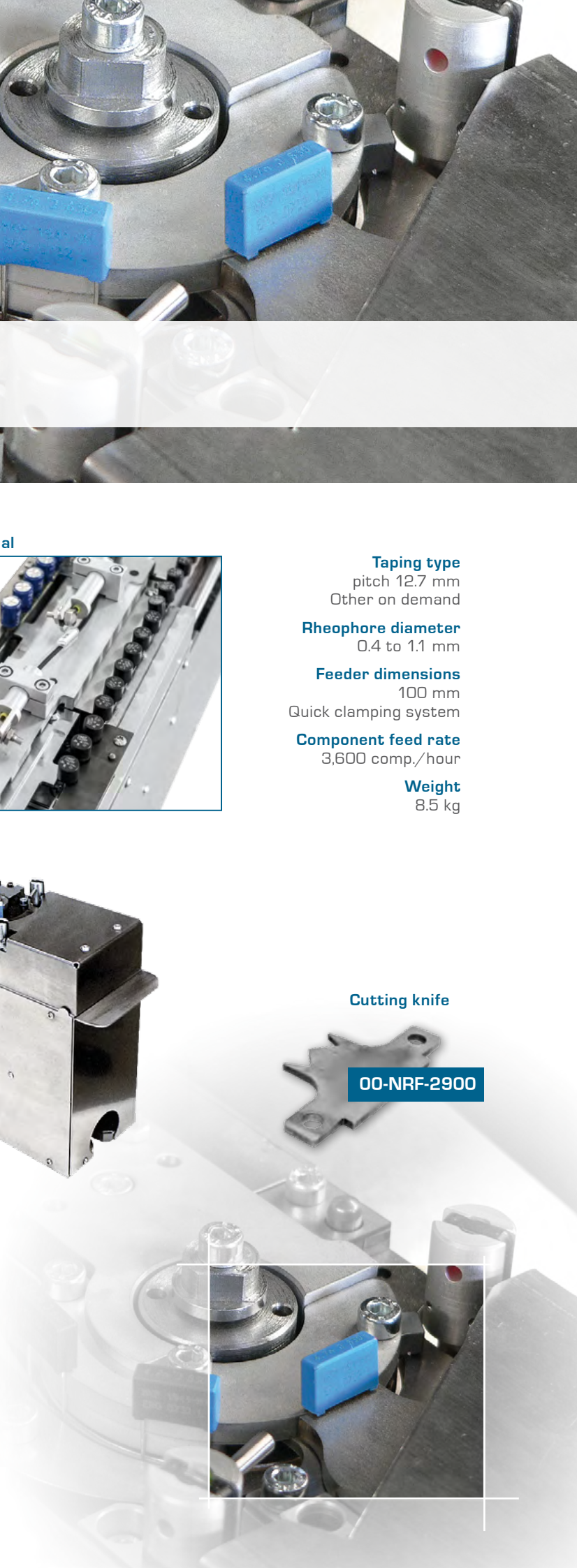
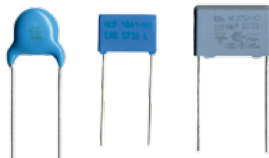
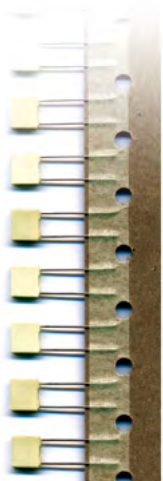

NEOAXIAL

Taping type

between 5 and 15 mm

Tape width

55 to 100 mm

Rheophore diameter

0.4 to 1.4 mm

Feeder dimensions

100 mm

Quick clamping system

Component feed rate

3,600 comp./hour

Weight

8.5 kg

NAF-500

NAF-00

Customized Kit

00-NAF-2900

Component types

resistors, diodes, capacitors

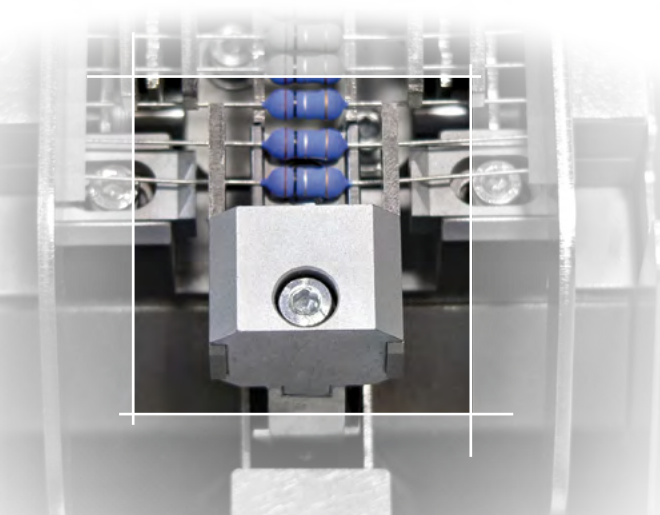
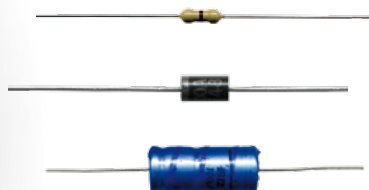
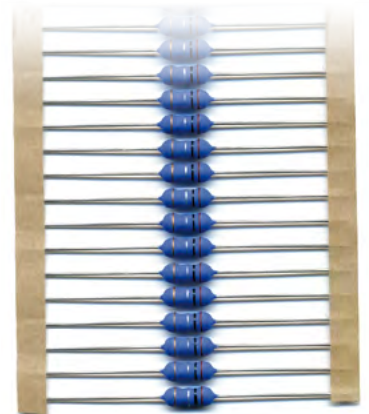
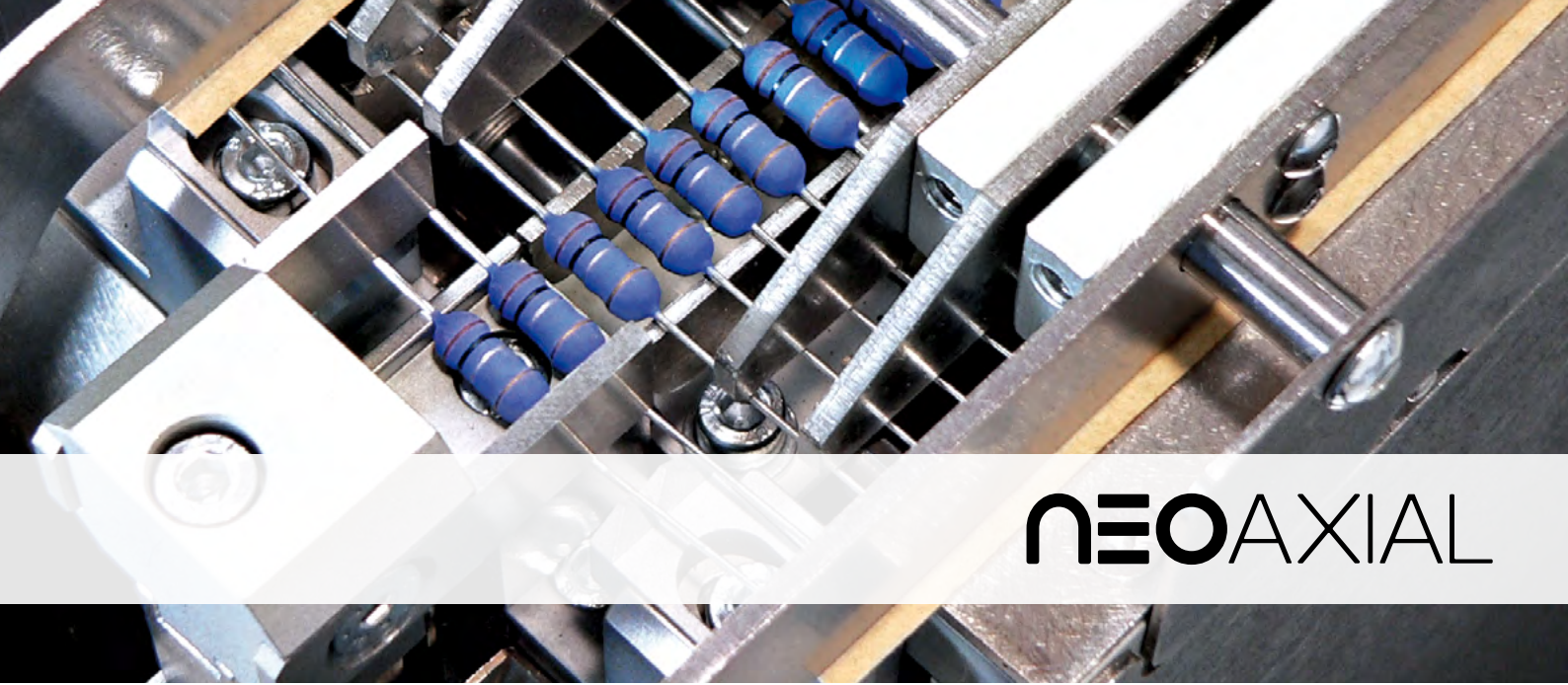

NEOTAPEDREEL

Taping type

Thermoformed tape and reel

Feeder dimensions

From 16 to 72 mm
Tapedreel interface needed
Quick clamping system

Component feed rate

3,600 comp./hour

Weight

8 kg (TRF-00)

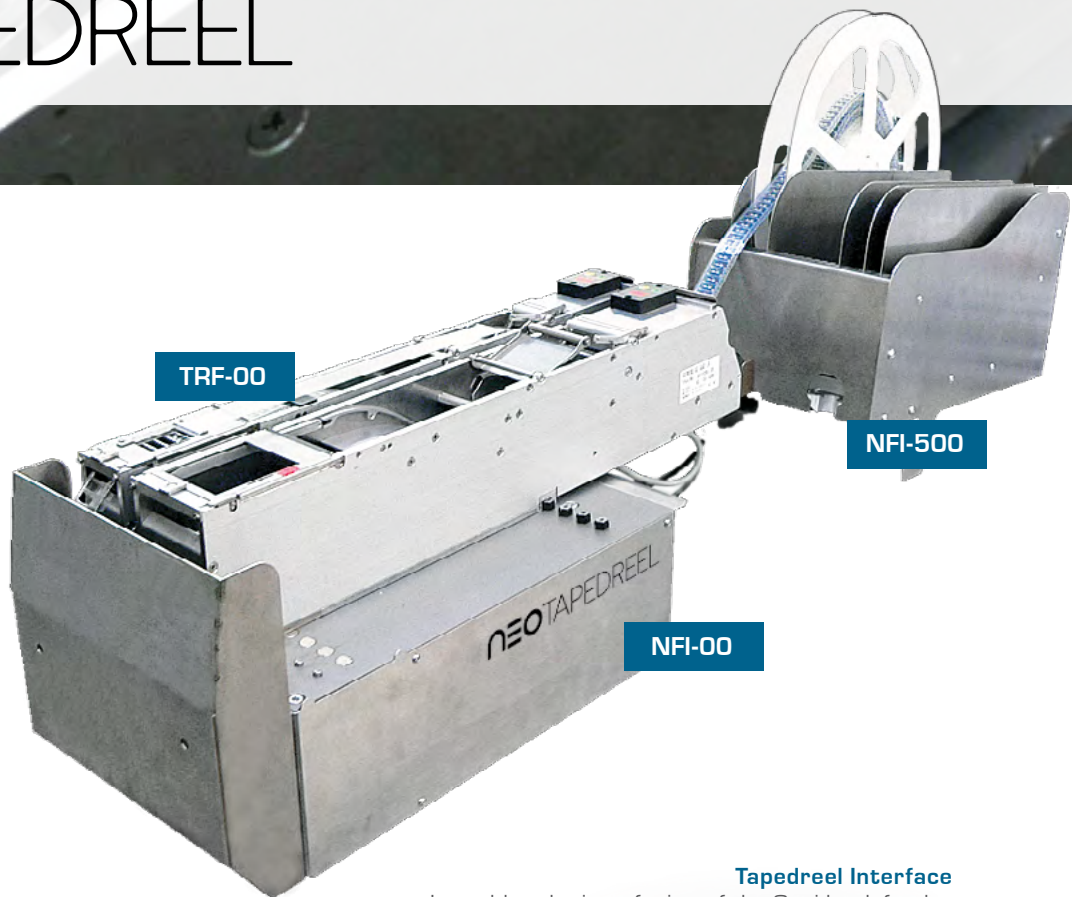

Component types

Connectors, terminals,
switches, shields, clips, etc

Tapedreel Interface

It enables the interfacing of the Osai bank feeder
with the Hover Davis, Siemens, Fuji feeders, etc

Interface dimensions

100 - 200 mm
Quick clamping system

Feeder capacity

max. 8

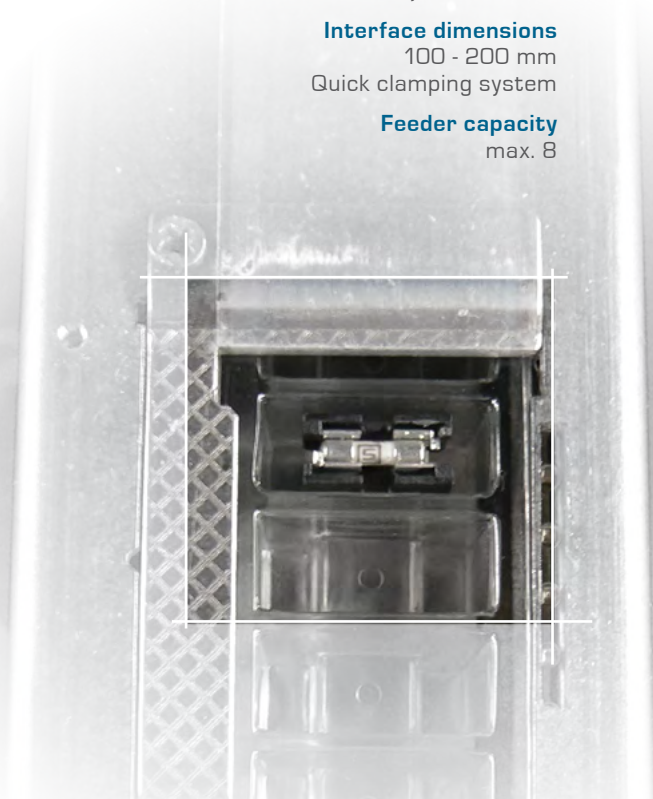

NEOSTICK



Packaging type
Plastic (DIN IEC 60286) or cardboard tube or stick

Tube dimensions
Width: 8 to 30 mm
Height: 8 to 35 mm
Length: 380 to 560 and 480 to 660 mm

Autonomy / Capacity
10-35 tubes

Feeder dimensions
100 mm
Quick clamping system

Component feed RATE
3,600 comp./hour

Weight
8,5 kg (NSF-00)
25 kg (NLF-00)

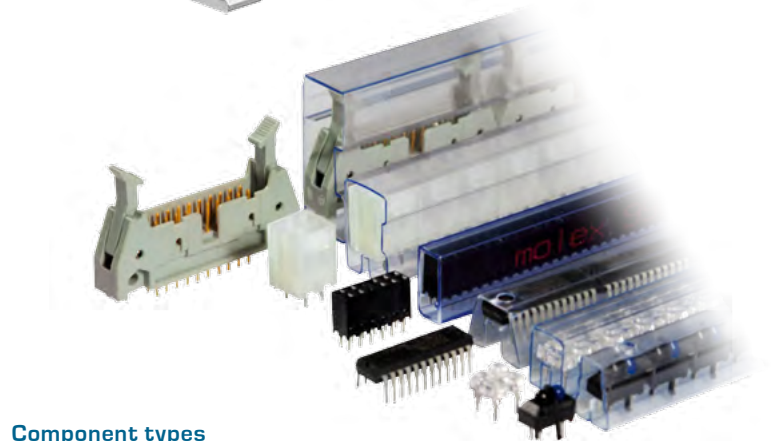

Component types
connectors, relays, transformers, displays,
switches, shields, IC, TO 220, etc.



NEOCOIL

It enables the trimming and/or pre-forming of some metallic parts such as fast-ons, pin, clips, contact foils, terminals, etc.

Feeder dimensions

100 mm

Quick clamping system

Component feed rate

1,800 parts/hour

Weight

20 kg



NCF-00

Coil support

Max. diameter 1.000mm
Coil power decoiler
Paper tape coiler
End-tape control sensor
Feed flexing control sensor

Foil types

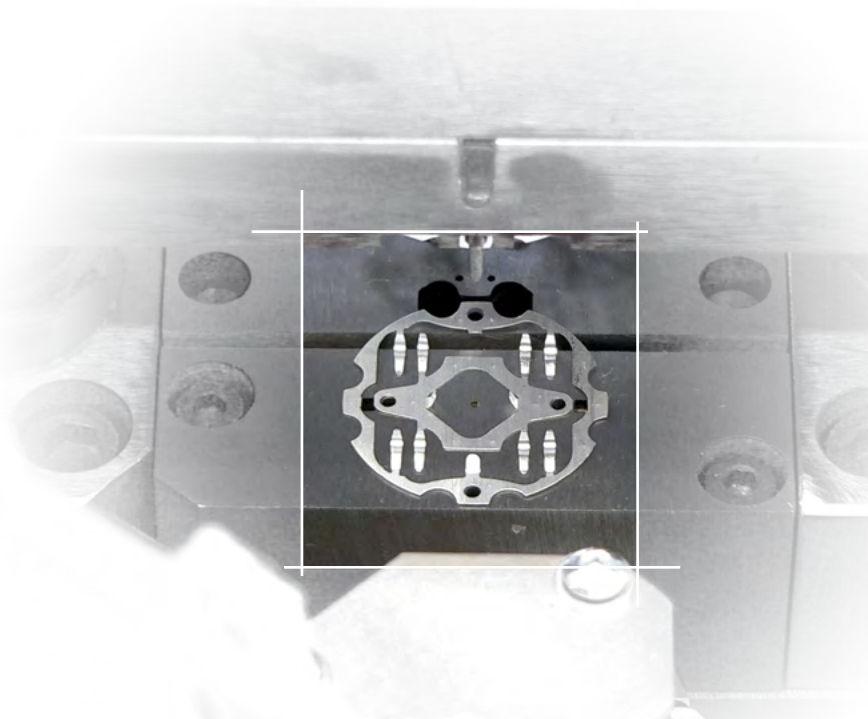
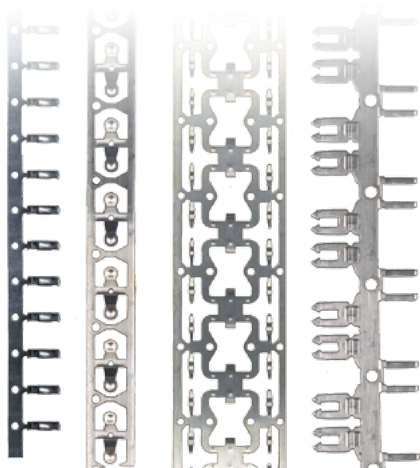



NEOBULK



NBF-00

NLF-00

NLF-300

Packaging type

Loose components

Operational autonomy

100 to 1,500 parts

Feeder dimension

100 mm

Quick clamping system

Component feed rate

3,600 comp./hour

Weight

40 kg [NBF-00]

25 kg [NLF-00]

Component types

connectors, terminals, switches, capacitors, clips, etc.

